

# ELLIPSE

Bartoli Design / 2001

DELIGHT

## Floor standing coat-hanger

**Frame:** elliptic aluminium tube with die-cast aluminium base in powder coated finish.  
Umbrella ring with removable water-collector and hanger in thermoplastic material.  
Version in white finish may have hooks in ivory, anthracite or aluminium as per customer's choice.



**Awards:**  
Adi Design Index

## Wall mounted coat hanger with 4 hooks, max load Kg.15 – length 60 cm.

Terminal elements and hooks in thermoplastic material.

**Frame** in aluminium tube in powder coated finish.  
Version in white finish may have hooks in ivory, anthracite or aluminium as per customer's choice.



	Article	pcs / dimensions volume / gross weight product net weight
Floor standing coat-hanger	E300SP	1 pc / 41x41x176 cm 0,30 m3 / 16 Kg
Floor standing coat-hanger with umbrella's ring	E300SP P	1 pc / 41x41x176 cm 0,30 m3 / 16,2 Kg
Wall-mounted coat hanger with 4 hooks length 60 cm	E300AP	4 pc / 65x20x20 cm 0,03 m3 / 4,5 Kg 1 Kg

## Finishes

### Frame

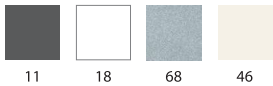

## Note

Art. E300AP Max loading capacity for each hook kg.15

## Additional costs

Bicoloured version: frame/hangers  
E300SP / E300SP M  
Bicoloured version: frame/hangers/  
umbrella's ring E300SP P

## Dimensions

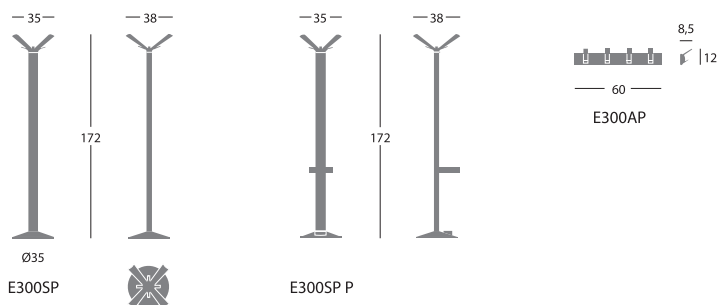

# ELLIPSE

Bartoli Design / 2001



Trolley coat hanger with 24 hooks or with 1 shelf and hooks or with 2 shelves on castors

**Frame:** steel in powder coated finish  
Terminal element and 24 hooks (applied on both sides of the bar) in thermoplastic material (for art. E300SER2/E300SRC)  
**Bar:** aluminium tube.  
**Shelves:** powder coated perforated steel luggage rack and hat rack (for art. E300SRC - E300SRG).

Version in white finish may have hooks in ivory, anthracite or aluminium as per customer's choice.



	Article	pcs / dimensions volume / gross weight product net weight
Trolley coat hanger on wheels with 24 hooks	E300SR 2	1 pc / 16x16x192 cm 1 pc / 62x9x186 cm 0,15 m3 / 16 Kg
Trolley coat hanger on wheels with top shelf and 24 hooks	E300SR C	1 pc / 16x16x196 cm 1 pc / 62x9x186 cm 0,15 m3 / 25 Kg
Trolley dress hanger on wheels with 2 shelves	E300SR G	1 pc / 16x16x192 cm 1 pc / 50x15x176 cm 0,18 m3 / 34 Kg

## Finishes

Frame

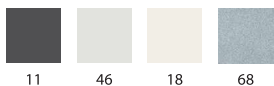

## Dimensions

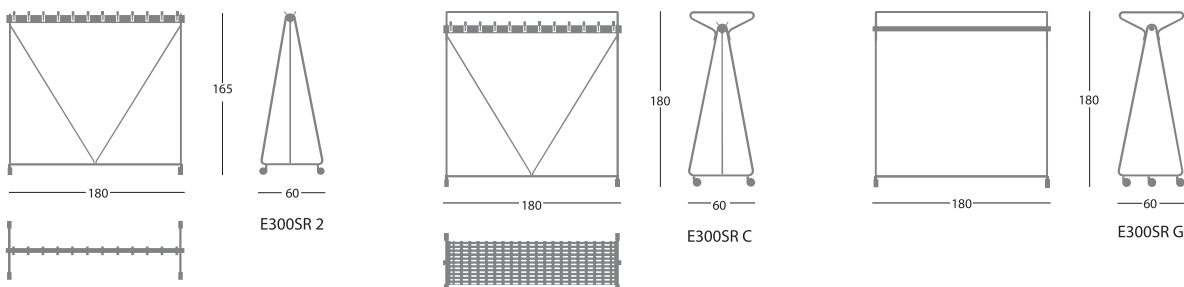

# ELLIPSE

Bartoli Design / 2001

DELIGHT

Containing elements available  
in H. 37 cm

**Frame:** steel in powder coated finish  
Water collector and gaskets in anthracite self-extinguishing ABS.  
Differentiated waste disposal container in polystyrene.  
Bin liner inner bag holder in powder coated steel.



Awards:  
Adi Design Index



	Article	pcs / dimensions volume / gross weight product net weight
Low wastepaper basket	E400GB	1 pc / 38x25,5x39,5 cm 0,04 m <sup>3</sup> / 3 Kg
Differentiated waste container	E400RD	Packed together with E400GB
Water collector	ME400PVVAS	Packed together with E400GB
Bin liner support	E400RI330 H.33 cm for Art. E400GB	Packed together with E400GB

## Finishes

Frame

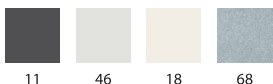

11

46

18

68

## Dimensions

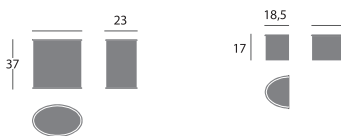

E400GB

E400RD

# ELLIPSE

Bartoli Design / 2001



Ashtray with sand-collector and waste paper basket.

Frame: steel in powder coated finish.

Chromed sand-tray.

The upper funnel-shaped part is self-extinguishing; in case of fire it stops the oxygen exchange and inhibits flame propagation.

Gaskets in anthracite self-extinguishing ABS.

Bin liner inner bag holder in powder coated steel.



Awards:  
Adi Design Index



	Article	pcs / dimensions volume / gross weight product net weight
Ashtray with sand-collector and waste paper basket	E400PG chromed top plate	1 pc / 38x25,5x69,5 cm 0,07 m <sup>3</sup> / 5,4 Kg
Bin liner support	E400RI330 H.33 CM for art. E400PG	Packed together with E400PG

## Finishes

Frame



11 46 18 68

## Dimensions

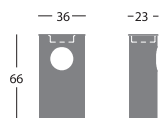

E400PG